

Installation and User Instructions

EasyCon Controller

Product Model: EasyCon-1

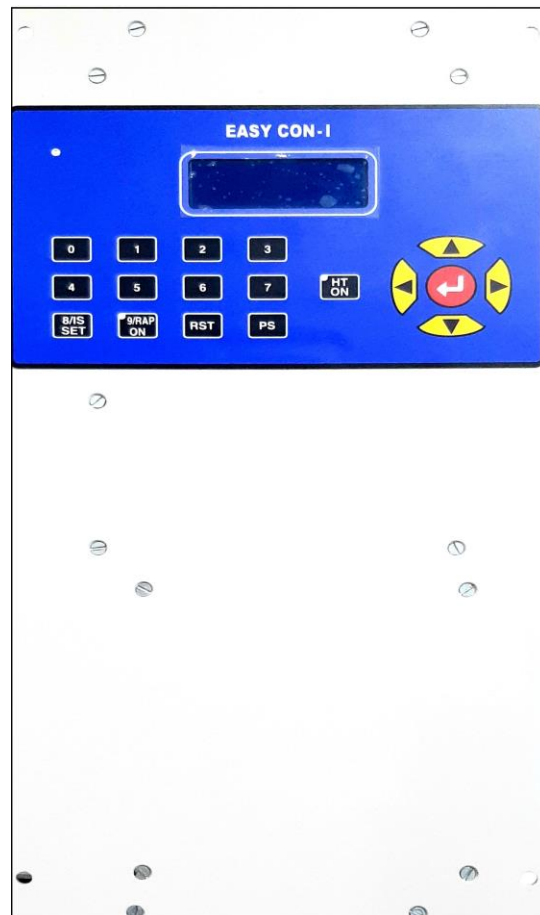

August 2019

Version 2.00

Copyright © 2019 by [EasyGo Technologies]

All rights reserved. No part of this publication may be reproduced, distributed, or transmitted in any form or by any means, including photocopying, recording, or other electronic or mechanical methods, without the prior written permission of the publisher. For permission requests, write to the publisher, addressed “Attention: Permissions Coordinator,” at the address below.

[EasyGo Technologies] [S.No.243, Behind Bank of Maharashtra, Phase – II, Hinjawadi, Pune - 411057]
[+91 7020251400] [Fax] [www.easygo.co.in]

TRADEMARKS

Document Revisions

Date	Version Number	Document Changes
14-07-2019	1.0	First release of Manual
07-08-2019	2.0	Second Release of Manual

Approvals

This document requires following approvals:

Name	Title

Distribution

This document has been distributed to:

Name	Title

Table of Contents

1	PREFACE	6
1.1Description of the User.....	6
1.2Conventions Used in This Manual	6
1.3Explanation of Safety Warnings.....	7
1.4Obtaining Documentation and Information	8
1.4.1	Internet.....	8
1.4.2	Ordering Documentation	8
1.4.3	Documentation Feedback	8
2	DESCRIPTION OF THE PRODUCT	9
2.1Purpose of the Product.....	9
2.2Process Overview	10
2.3Technical Specifications	11
3	SAFETY INSTRUCTIONS.....	12
3.1How to Use the Product Safely.....	12
3.1.1	Important Safety Instructions.....	12
4	CONTROL AND USER INTERFACE	13
4.1Control & LED Indications	13
4.2Display.....	13
4.3Keys	13
5	DEFAULT DISPLAY.....	14
6	PARAMETER PROGRAMMING	15
6.1Parameter Programming Instructions	15
6.2Editing and Storing of TR Set Parameters.....	16
6.2.1	Rated DC Current Rating of TR Set (Parameter No: 74)	16
6.2.2	Rated DC Voltage Rating of TR Set (Parameter No: 73)	16
6.2.3	Rated Primary AC (RMS) Current Rating of TR Set (Parameter No: 76)	17

6.3Minimum and Maximum Values of the Parameters.....	18
6.3.1	Read Only Parameters	18
6.3.2	Read / Write Parameters.....	19
6.3.3	Read / Write Rapper Operation Parameters	19
6.3.4	Read / Write Transformer Setting Parameters.....	21
6.3.5	Read / Write Special Function Parameters.....	22
7	ALARM / TRIP MESSAGE	24
7.1Alarm / Trip Acknowledge and Alarm / Trip Reset Functions	24
7.2Rapper Operation.....	25
8	INSTALLATION.....	26
8.1Connector Installation Description.....	26
8.1.1	J1 TRIP	26
8.1.2	J2 ALM/RAP	26
8.1.3	J3 SCR FIRING.....	27
8.1.4	J4 RELAY OUTPUT	27
8.1.5	J5 FUSE 2A	28
8.1.6	J8 PRIMARY FEEDBACK	28
8.1.7	J9 SECONDARY FEEDBACK	28
9	OPERATION	29
10	TROUBLESHOOTING AND REPAIR.....	30
11	Appendices.....	31
11.1	..Supplied Accessories, Consumables and Spare Parts.....	31
11.1.1	Supplied accessories.....	31
11.1.2	Consumables	31
11.1.3	Spare/replacement parts	31
12	GLOSSARY	32
13	RELATED DOCUMENTATION	33

1 PREFACE

1.1 Description of the User

This user manual is intended to use by service person, installer, operator and/or end-user.

Installer or service person need to be skilled and trained person, he must have the basic knowledge of handling electrical systems, wiring connections, diagnostic instruments like multimeter, oscilloscope etc

1.2 Conventions Used in This Manual

The following style conventions are used in this document:

Bold

Names of product elements, commands, options, programs, processes, services, and utilities

Names of interface elements (such windows, dialog boxes, buttons, fields, and menus)

Interface elements the user selects, clicks, presses, or types

Italic

Publication titles referenced in text

Emphasis (for example a new term)

Variables

Courier

System output, such as an error message or script

URLs, complete paths, filenames, prompts, and syntax

User input variables

< > Angle brackets surround user-supplied values

[] Square brackets surround optional items

| Vertical bar indicates alternate selections - the bar means “or”

1.3 Explanation of Safety Warnings

DANGER!

Danger indicates a hazard with a high level of risk which, if not avoided, will result in death or serious injury

WARNING!

Warning indicates a hazard with a medium level of risk which, if not avoided, could result in death or serious injury.

CAUTION!

Caution indicates a hazard with a low level of risk which, if not avoided, could result in minor or moderate injury.

1.4 Obtaining Documentation and Information

1.4.1 Internet

The latest version of the documentation is available at the following address:

<http://www.easygo.co.in>

1.4.2 Ordering Documentation

Documentation, user instructions and technical information can be ordered by calling

Omprakash Karamunge @ +91 7020251400, +917588067505, easygotechnologies@gmail.com

1.4.3 Documentation Feedback

If you are reading **EasyGo Technologies** product documentation on the internet, Feedback can be submitted on the support website. Feedback can also be sent to support@easygo.co.in

We appreciate your valuable feedback.

2 DESCRIPTION OF THE PRODUCT

2.1 Purpose of the Product

EasyCon is the latest Generation Micro Controller for Electrostatic Precipitator application. It is a powerful tool for Clean Air Management which also regulates, monitors and optimizes the Electric Power Input to ESP.

- **Constant current source:** Soft start at Power ON and then fine control action for archiving constant current throughout the load variation.
- **Improved Collection Efficiency:** Digital detection enables sensing of sparks, arcs and together with control philosophy of flashovers, increases the "Volt Time Integral" and lif3e collecting electrodes.

Instant detection of spark, arc and together even at less than 5% of rated current and then instant action to control by reducing as power as per setting and again fast rise in power to achieve high dust collection.

- **Charge Ratio:** Pulsed Operation with a higher range up to 1:255 for improving precipitation and/or for energy saving depending upon the type of process, dust resistivity, etc. Additional facility of "Recharge Voltage" during the blocked periods increases the trough voltage, which enhances the collection efficiency.

Maximum range of charge ratio up to 1:255 for energy savings along with maximum collection.

- **Load Status Mode:** Enabling selection between different operating parameter values for varying plant conditions.
- **2 Spare Digital Inputs:** 2 alarm for faults
- **Display:** Advanced Man/Machine communication through keyboard and LCD Display of KV (Mean), mA (mean) and KV (P) values. User Friendly operator interface with communication in a message form and in engineering units.

2.2 Process Overview

Below figure shows the basic operation of ESP system and the EasyCon controller position.

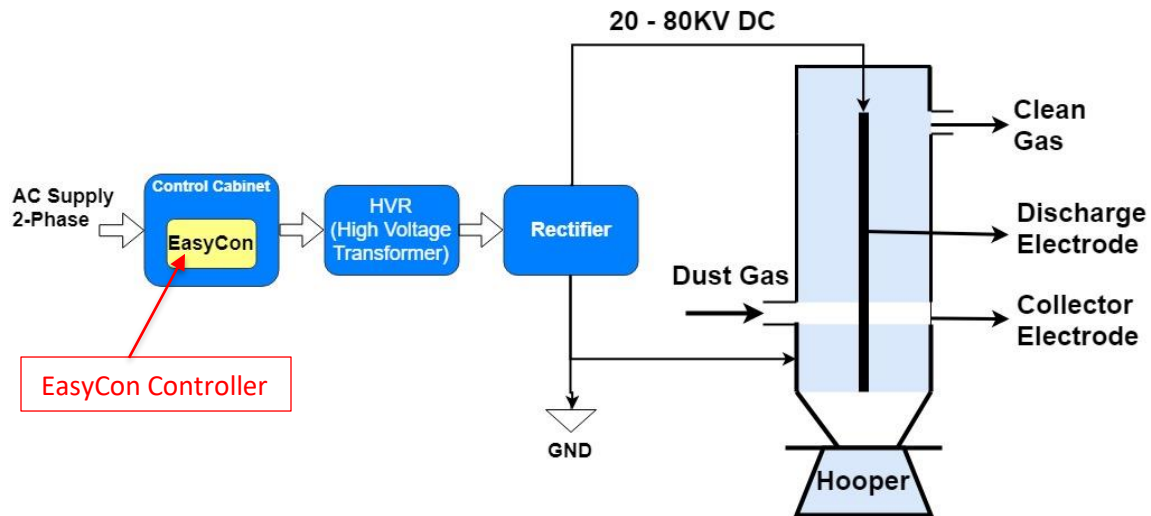

Electrostatic Precipitator System

Control Cabinet: Control cabinet is used to interconnect the 3-phase supply and transformer through cables

Transformer: Transformer is used to step up or step-down voltage as per design of Electrostatic precipitator

Rectifier: Rectifier is used to convert ac supply into dc supply

Hooper: It is used to store dust particles and ash content coming out from the ESP

2.3 Technical Specifications

Environment	
Ambient Temperature	0 to 50°C (Max.)
Storage Temperature	0 to 80° C
Duty	Continuous operation (24 hours a day)
Installation	Indoor

Mains Requirement	
Nominal Input Voltage	24V AC ($\pm 10\%$), 1 ϕ
Nominal Input Frequency	50 Hz ($\pm 5\%$)
Current	2 A RMS (Max)

Feedback's for Operation	
Output Current Feedback (I_{DC})	1V DC @ rated mA Average (Mean) DC
Output Voltage Feedback (V_{DC})	400 μ A DC @ rated KV (Peak)
Primary Current Signal (I_P)	80mA (RMS) @ rated Primary Input Current.
Digital Inputs	Potential Free Contacts
Digital Outputs	Potential free contacts of 3A @ 24VAC (Max.)

3 SAFETY INSTRUCTIONS

WARNING! The electronics in the EasyCon Controllers are designed for indoor, clean environment. When installed in dusty and/or corrosive environment, outdoor or indoor, it is important to:

Install an appropriate filter on the enclosure door, or on the room's air control systems

Keep the enclosure door closed during operation

Replace the filter on regular basis

3.1 How to Use the Product Safely

3.1.1 Important Safety Instructions

- The EasyCon panel can reach hazardous leakage currents, Earthing must be carried out prior energizing the system. Earthing shall be made according to local regulations
- Prior to any work conducted to a system/unit make sure that power supply input voltage is disconnected
- Do not remove cover until 2 minutes after disconnecting all sources of supply
- Warning labels must not be removed
- Never wear metallic objects such as rings, watches, bracelets during installation, service and maintenance of the product
- Insulated tools must be used at all times when working with live systems
- When handling the system/units pay attention to sharp edges
- ESD strap must be worn when handling PCBs and open units
- The equipment must be installed and commissioned by skilled technicians according to instructions in this manual
- Local regulations must be adhered
- The manufacturer declines all responsibilities if equipment is not installed, used or operated according to the instructions herein by skilled technicians according to local safety regulations
- Warranty does not apply if the product is not installed, used and handled according to the instructions in the manual
- EasyGo Technologies cannot be held responsible for disposal of the system and therefore the customer must segregate and dispose the materials which are potentially harmful to the environment, in accordance with the local regulations in force in the country of installations

4 CONTROL AND USER INTERFACE

4.1 Control & LED Indications

LED Indication on the front fascia of the Keyboard

S.no.	Description	Status	Function	Default Condition
1	HT ON/OFF	LED/LCD Indication	Contactors 'ON'	HT Off
2	Watchdog	LED Indication	Unit Healthy	Flashing
3	RAPPER ON/OFF	RAP ON Indication	Rapping ON	RAP Off

4.2 Display

The Display module is an LCD alpha numeric with 4 lines of 20 characters each, with 5 x 7 dot matrix having blue-lit facility for operations in poor light conditions.

4.3 Keys

Non-tactile keypad is used for all the control functions

The functions of the keypad are as follows:

Keys	Description
HT ON/OFF	For switching ON/OFF the HT contractor (Toggle)
INC & DEC	Scrolling the parameters
RST	Accept & Reset of Alarm/Trip Faults
PS	Parameter Programming
ENTER	Confirming & Storing the Parameter values
0 - 9	Numeric Keys

5 DEFAULT DISPLAY

After power ON the EasyCon-1 controller, LCD display will show default screen as follows:

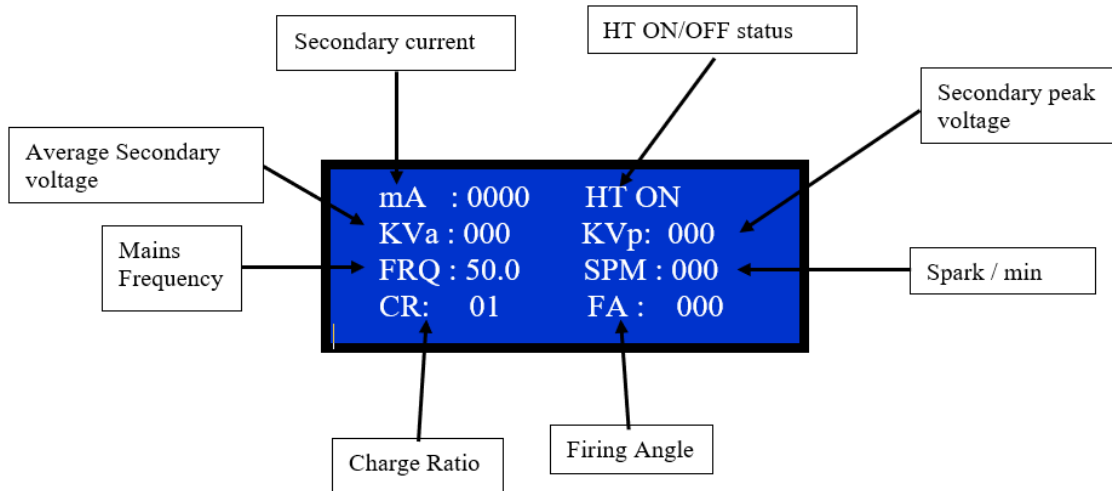

6 PARAMETER PROGRAMMING

6.1 Parameter Programming Instructions

The user must refer to the parameter settings mentioned in clause No. 5.3 for setting the values of various parameters. This list also includes the factory programmed default values.

For editing the parameter values press “PS” key. Enter the parameter number which is one more than the parameter that needs to be modified and press the enter key.

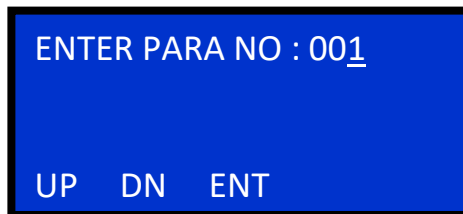

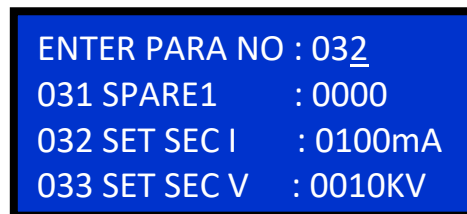

```
ENTER PARA NO : 001
UP  DN  ENT
```

Three consecutive parameter values will appear on the screen.



```
ENTER PARA NO : 032
031 SPARE1      : 0000
032 SET SEC I   : 0100mA
033 SET SEC V   : 0010KV
```

In order to edit the values, use left and right keys. The right arrow key  is used to go to the next line where the required value can be entered, and the left arrow key  is used to go to the previous line

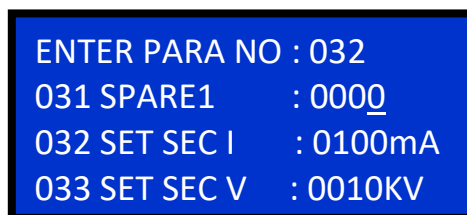

```
ENTER PARA NO : 032
031 SPARE1      : 0000
032 SET SEC I   : 0100mA
033 SET SEC V   : 0010KV
```

The up and down arrows can be used to go to the next and previous parameter respectively.

Only the first line parameter values can be set. The parameter value which needs to be changed, should be scrolled to the first line and then the value can be entered.

6.2 Editing and Storing of TR Set Parameters

6.2.1 Rated DC Current Rating of TR Set (Parameter No: 74)

LOWER LIMIT: 0 mA

UPPER LIMIT: 2000 mA

Enter parameter No. 75 so that the first line will display Parameter no. 74 value which can be changed.

Enter the rated DC current rating of the TR set.

Ex: For TR set having 1000mA DC as output current, the display after entering the rated mA will be as follows.

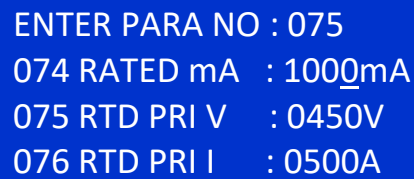

```
ENTER PARA NO : 075
074 RATED mA   : 1000mA
075 RTD PRI V  : 0450V
076 RTD PRI I  : 0500A
```

6.2.2 Rated DC Voltage Rating of TR Set (Parameter No: 73)

LOWER LIMIT: 0 KV

UPPER LIMIT: 200 KV

Enter parameter No. 74 so that the first line will display Parameter no. 73 value which can be changed.

Enter the rated DC Peak Voltage rating of the TR set.

Ex: For TR set having 100 KV DC as peak Voltage rating, the display after entering the value will be as follows.

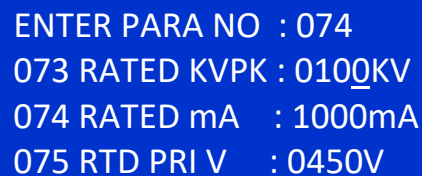

```
ENTER PARA NO : 074
073 RATED KVPK : 0100KV
074 RATED mA   : 1000mA
075 RTD PRI V  : 0450V
```

6.2.3 Rated Primary AC (RMS) Current Rating of TR Set (Parameter No: 76)

LOWER LIMIT: 0 A

UPPER LIMIT: 500 A

Enter parameter No. 77 so that the first line will display Parameter no. 76 value which can be changed.

Enter the rated primary current rating of the TR set.

Ex: For TR set having 200 A as the primary current rating

```
ENTER PARA NO : 077
076 RTD PRI I  : 0200mA
077 PRI I LIM  : 0450A
078 COND ANL  : 0000D
```

6.3 Minimum and Maximum Values of the Parameters

6.3.1 Read Only Parameters

Para No	Para Name	Min	Max	Default	R/W	Unit	Details
1	ALM STS	0	65535	0	R		Not applicable
2	TRIP STS	0	65535	1	R		Not applicable
3	KV avg	0	65535	1	R	KV	KV average
4	KV pk	0	65535	0	R	KV	KV peak
5	KV tr	0	65535	0	R	KV	KV tr
6	mA avg	0	200	0	R	mA	mA
7	SPARE	0	200	0	R		Not applicable
8	SPARE	0	200	0	R		Not applicable
9	SEC PWR	0	2000	0	R	KW	Sec. DC Power
10	SPRK_RATE	0	2000	0	R	/Min	SPRK_RATE / Min
11	SET SPARK	0	2000	0	R	/Min	SET SPARK / Min
12	IP VTG RY	0	2000	0	R	V	IP VTG RY
13	SPARE	0	300	0	R		Not applicable
14	SPARE	0	300	0	R		Not applicable
15	PRI CUR	0	600	0	R	A	Primary Current
16	SPARE	0	600	0	R		Not applicable
17	SPARE	0	600	0	R		Not applicable
18	COND ANG	0	600	0	R	Deg	Firing Angle
19	PHASE ANG	0	600	0	R	Deg	Not applicable
20	MAINS FRQ	0	600	0	R	Hz	MAINS FRQ
21	ACT. PWR	0	180	0	R	KW	Not applicable
22	INPUT KVA	0	180	0	R	KW	Not applicable
23	POWER FAC	0	70	50	R		Not applicable
24	SPARK CNT	0	2000	0	R		SPARK CNT
25	ARC COUNT	0	2000	0	R		Not applicable

26	TIME TOT	0	100	0	R	Sec	Not applicable
27	RAP STS	0	65535	0	R		No of RAP's ON
28	ALM ACK	0	65535	0	R		Not applicable
29	RELAY STS	0	65535	0	R		Not applicable
30	HT ON/OFF	0	1	0	R		Not applicable
31	SPARE1	0	1	0	R		Not applicable

6.3.2 Read / Write Parameters

Para No	Para Name	Min	Max	Default	R/W	Unit	Details
32	SET SEC I	0	500	100	R/W	mA	Set Secondary Current
33	SET SEC V	0	200	10	R/W	KV	Not applicable
34	CR COUNT	0	100	0	R/W		Not applicable
35	MAX SPR/M	0	100	10	R/W	/Min	Maximum spark rate
36	ENG DRP	0	100	30	R/W	%	Drop in mA after spark
37	OFF CYCLE	0	30	5	R/W		OFF cycle after spark
38	OFREC CYC	0	100	30	R/W		Recovery cycle after spark
39	REC_ENG	0	100	70	R/W	%	Fast rise in mA after spark in %
40	REC ENG %	0	100	30	R/W	%	Time for fast rise after spark
41	SPARE 4	0	100	10	R/W		Not applicable
42	ARC DET	0	100	0	R/W		Not applicable

6.3.3 Read / Write Rapper Operation Parameters

Para No	Para Name	Min	Max	Default	R/W	Unit	Details
43	COL STR T	0	10	5	R/W	Min	Start time

44	COL RUN T	0	100	30	R/W	Sec	COL Rapper ON Time
45	COL REP T	0	1000	1	R/W	Min	Total ON + OFF = REPEAT Time
46	COL STP D	0	1440	5	R/W	Min	Stop delay time
47	RAP REP R	0	100	0	R/W		Not applicable
48	COL RED I	0	100	0	R/W	mA	Not applicable
49	PITRP_Y_N	0	1	0	R/W		Primary Current Trip YES/NO
50	COL CNTON	0	1	0	R/W		COL RAP CONTINUOUS ON
51	EM STRT T	0	100	0	R/W	Min	Start time
52	EM RUN T	0	1000	30	R/W	Sec	EM Rapper ON Time
53	EM REP T	0	1440	5	R/W	Min	Total ON + OFF = REPEAT Time
54	EM STP D	0	100	0	R/W	Min	Stop delay time
55	EM CNT ON	0	1	0	R/W		EM RAP CONTINUOUS ON
56	SPARE	0	100	0	R/W		Not applicable
57	GD RUN T	0	1000	30	R/W	Sec	GD Rapper ON Time
58	GD REP T	0	1440	5	R/W	Min	Total ON + OFF = REPEAT Time
59	GD STP D	0	100	0	R/W	Min	Stop delay time
60	GD CNT ON	0	1	0	R/W		GD RAP CONTINUOUS ON
61	SPARE	0	100	0	R/W		Not applicable
62	SPARE	0	1000	0	R/W		Not applicable
63	SPARE	0	1440	0	R/W		Not applicable
64	SPARE	0	100	0	R/W		Not applicable
65	SPARE	0	1	0	R/W		Not applicable
66	COL ONOFF	0	1	0	R/W		COL ONOFF
67	EMT ONOFF	0	1	0	R/W		EMT ONOFF

68	GD ONOFF	0	1	0	R/W		GD ONOFF
69	SPARE	0	1	0	R/W		Not applicable
70	RED ONOFF	0	1	0	R/W		Not applicable

6.3.4 Read / Write Transformer Setting Parameters

Para No	Para Name	Min	Max	Default	R/W	Unit	Details
71	I/P V_TXR	0	500	500	R/W	V	Input Voltage
72	I/P I_TXR	0	500	200	R/W	A	Input Current CT
73	RTED KVPK	0	200	100	R/W	KV	KV Rating of TX
74	RATED mA	0	2000	1000	R/W	mA	mA Rating of TX
75	RTD PRI V	0	500	100	R/W	V	Primary Voltage
76	RTD PRI I	0	500	200	R/W	A	Primary Current
77	PRI I LIM	0	500	0	R/W	A	Primary Current Trip Limit
78	COND ANGL	0	180	0	R/W	Deg	Not applicable
79	O/P PWR L	0	5000	0	R/W	KW	Not applicable
80	UV LIMIT	0	100	0	R/W	KV	Under Voltage Trip limit
81	UV TRIP D	0	200	30	R/W	Sec	Under Voltage Trip delay in sec
82	OV LIMIT	0	500	0	R/W	KV	Over Voltage Trip limit
83	INIT_Y_N	0	550	0	R/W		Not applicable
84	PRUVTRLIM	0	1000	0	R/W	V	Not applicable
85	PROVTRLIM	0	1000	0	R/W	V	Not applicable

6.3.5 Read / Write Special Function Parameters

Para No	Para Name	Min	Max	Default	R/W	Unit	Details
86	M1 KV LIM	0	200	20	R/W	KV	Not applicable
87	M1_mA LIM	0	2000	50	R/W	mA	Not applicable
88	M1SPRRATE	0	100	10	R/W		Not applicable
89	RAP_ONOFF	0	1	0	R/W		All Rap ON/OFF
90	SPARE	0	500	0	R/W		Not applicable
91	BC ON/OF	0	1	0	R/W		Not applicable
92	BC MODE	0	2	0	R/W		Not applicable
93	BCSAMRATE	0	50	0	R/W	Sec	Not applicable
94	HOLD_TIME	0	100	20	R/W	Sec	Not applicable
95	BC I STEP	0	100	50	R/W		Not applicable
96	MIN mA DET	0	100	50	R/W	mA	Not applicable
97	BC OP MOD	0	1	0	R/W	KW	Not applicable
98	BC MAX CR	0	15	1	R/W		Not applicable
99	MAX CR	0	25	1	R/W		Charge Ratio
100	AUTOOPTON	0	1	0	R/W		Not applicable
101	SPR HW	0	5000	500	R/W		Not applicable
102	SPR SW	0	5000	4000	R/W		Not applicable
103	DIMMER FA	0	180	165	R	Deg	Not applicable
104	MIN FIR A	0	20	16	R/W	Deg	Not applicable
105	MAX FIR A	0	175	165	R/W	Deg	Not applicable
106	REM SEL	0	1	0	R/W		Not applicable
107	REMRAPON	0	1	0	R/W		Not applicable
108	REMRAPRED	0	1	0	R/W		Not applicable
109	UV TRPLIM	0	10	3	R/W	KV	Under Voltage Trip limit
110	OV TRPLIM	0	200	80	R/W	KV	Over Voltage Trip delay in sec

111	SPARE	0	100	0	R/W		Not applicable
112	AC I HIGH	0	500	100	R/W	A	Primary Current High Limit

7 ALARM / TRIP MESSAGE

The Alarm/Trip message is displayed on the bottom line. In case of Alarms/Trips, the Alarm message remains on the screen until Acknowledged/Reset by the operator with “RESET” key.

Alarm / Trip Message	Alarm / Trip Message Description
Top Float Alarm	Top float alarm (Oil level low for Hermetically sealed TR)
TR Temp High Alarm	Transformer oil temp high alarm
Overload Trip	Overload trip
Safety Loop Fail Trip	Safety loop fail
SCR Temp High Trip	SCR temp high trip
Bot Oil Lev Trip	Bottom float trip (TR pressure high for Hermetically sealed TR)
TR Temp High Trip	Transformer oil temp high trip

Apart from these alarm / trip faults the Optional Alarms & Trips faults will be displayed as they are programmed

7.1 Alarm / Trip Acknowledge and Alarm / Trip Reset Functions

Whenever Alarm / Trip fault occurs corresponding Alarm / Trip text message appears on the LCD (as shown below)



The text message represents the actual Alarm/Trip Fault occurred.

The reset key is used for resetting the fault.

On occurrence of Trip faults ‘HT’ is made ‘OFF’. If the Alarm/Trip fault persists then ‘HT’ cannot be made ‘ON’ & if the reset key is pressed again, the relays will remain in energized condition & the text message will continue appearing on the LCD.

7.2 Rapper Operation

Three potential free contacts are available for the motorized rapper operation.

Rapper ON time will be set in seconds from 1 to 120sec.

Rapper repetition time is addition of Rapper ON time and Rapper OFF time. This can be set in minutes from 1 to 1440 min.

For ex: If Rap ON time is 30sec and Rap Rep time is 2min, Then Rapper will ON for 30 sec and OFF for 90sec.

Individual settable parameters such as Run, Repeat and ON/OFF time are available for all three rappers. Please find parameter list for more details (in 6.3.3).

Common RAP ON/OFF key along with LED indication is available on KEYPAD.

If Rapper is ON and feedback is not received in 30sec, then Rap fail Alarm will pop up on LCD display.

8 INSTALLATION

8.1 Connector Installation Description

8.1.1 J1 TRIP

It is used to monitor the trips like Tx Temp High, Oil Level Low/Bot float, SCR Temp High, Safety Loop Fail, Overload. When any one of the trips occur, the HT (HT Contactor (Toggle)) will be OFF and corresponding message will pop up on LCD display

It receives HV contactor feedback.

J1 TRIP	
1	Tx Temp High
2	Oil Level Low/Bot float
3	SCR Temp High
4	Safety Loop Fail
5	Over Load
6	HV CON FB
7	DIG_Gnd
8	DIG_Gnd

8.1.2 J2 ALM/RAP

It is used to monitor the alarms like Tx Temp High, Top float.

J2 ALM / RAP	
1	Alarm 1
2	RAP 3 Feedback
3	Alarm 5
4	RAP 2 Feedback
5	RAP 1 Feedback
6	RAP Reduction
7	REM ON
8	Tx Temp High Alarm

9	Top Float Alarm
10	Alarm 2
11	Alarm 3
12	Alarm 4

8.1.3 J3 SCR FIRING

SCR connection details

J3 SCR FIRING	
1	SCR1 – (Cathode)
2	SCR2 + (Gate)
3	SCR2 - (Cathode)
4	SCR1 + (Gate)

8.1.4 J4 RELAY OUTPUT

Potential free NO contacts are available for Rapper, Buzzer, HT contactor operation.

J4 RELAY OUTPUT	
1	NC.
2	RAP1
3	LOC/REM
4	RAP 2
5	RAP 3
6	RLY 1
7	ALM/FAULT
8	BUZZER
9	HT ON
10	RLY 2
11	COM_POLE
12	COM_POLE

8.1.5 J5 FUSE 2A

It gives 24V AC input required for driving the controller.

J5 FUSE 2A	
1	24 AC
2	24 AC
3	Earth
4	24 AC N
5	24 AC N

8.1.6 J8 PRIMARY FEEDBACK

It gives Sync signal of 24V AC voltage, and Primary current sensing from current transformer.

J8 PRIMARY FEEDBACK	
1	24VAC2
2	24VAC1
3	PCB_Earth
4	IP2
5	IP1

8.1.7 J9 SECONDARY FEEDBACK

Secondary KV and mA feedback signal for measurement and control operation.

J8 PRIMARY FEEDBACK	
1	Vs-
2	Vs+
3	Is+
4	Is-
5	Shield_VsIs
6	Earth_Rectifier

9 OPERATION

- Connections should be made as per the connector installation description.
- Ensure all connections and Switch ON the supply.
- After energizing the controller, Controller starts its initialization activity.
- Watchdog LED starts flashing at 1Hz frequency.
- Display will show default screen after initialization (Ch-5)
- Before HV ON ensure the following things:
 - 1) Frequency 50.0Hz +/- 3Hz
 - 2) Ensure all the parameter settings related to TR rating.
 - 3) mA = 0000 (If cable noise is present, then it shows less than 10mA)
 - 4) KV_a = 000 (If cable noise is present, then it shows less than 2KV)
 - 5) KV_p = 000 (If cable noise is present, then it shows less than 5KV)
 - 6) Display should not show any Trip message
- Before connecting to TR, take the Lamp load and ensure soft start Lamp glowing operation.
- Connect TR and make HT ON. Ensure the mA rise from zero to set I_{DC} limit slowly and finally control the secondary current at set I_{DC} limit.
- After HT ON, if HV contactor feedback is not received then HV contactor becomes OFF and HV contactor fail message popup on LCD.

10 TROUBLESHOOTING AND REPAIR

WARNING: Do not repair product on site, please contact the service provider

11 Appendices

11.1 Supplied Accessories, Consumables and Spare Parts

11.1.1 Supplied accessories

Image	Name	Article Number

11.1.2 Consumables

Image	Name	Article Number

11.1.3 Spare/replacement parts

Image	Name	Article Number

12 GLOSSARY

Term	Meaning
ESP	Electrostatic Precipitator
MCU	Micro Controller Unit
KV	Kilo Volt
LCD	Liquid Crystal Display
HT	High Voltage Transformer
I_{dc}	Output DC Current
TR	Transformer
LED	Light Emitting Diode

13 RELATED DOCUMENTATION

#	Document Title	Version #	Location	Author